

UPTIME KIT

Maestro SW



INTRODUCTION

Thank you for your commitment to HORSCH!

Our goal is to help you and your HORSCH machine run as efficiently as possible. Unfortunately in farming, parts wear over time or even break which leads to downtime for hours or days. While we can't predict *everything* that can go wrong on your machine, ground engagement parts have the best chance to slow you down. That's why we have created this **Uptime Kit for the HORSCH Maestro SW**.

This kit includes parts that can help you make quick fixes to get your HORSCH machine up and running again as soon as possible without a call or trip to the dealership.





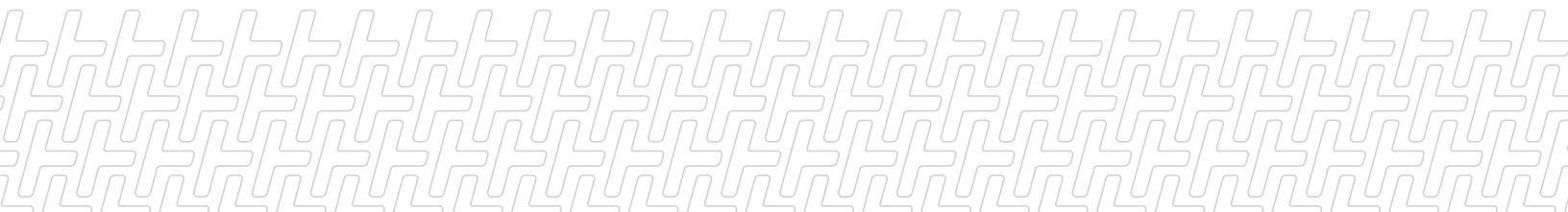









If you have questions, contact your local dealer!

Your HORSCH Parts Team



MAESTRO SW - UPTIME KIT PARTS

Part No	Part	Description	Qty
00170047		Hairpin, 1.8mm	1
00170210		Tension Spring, closing wheel	2
00200287		Dust Cap	2
00230096		Bushing GSM 40/44x30	4
00230103		Shim 16x22x 1	10
00230269		Shim 25x35x0.5	8
00230314		Adjusting Washer 16.30.1	8
00311179		Disc blade 15 w. bearing	2
00370312		Zerk, grease M8x1, 90 degrees	2
00370630		Washer, Ripp Lock	4
00370647		Threaded pin	2
05019941		Maestro Scraper	1
05024991		GW Axle Shaft	1
05034797		Laser, Washer, 12.5x50x25"	2

Part No	Part	Description	Qty
24012128		Shim 50x25x2	14
24017318		Corn Unit Cover	1
24017320		Pin, 6-67	1
24019001		Seed Tube Seal	1
24146603		Steel Square Bar 30x30-34	1
24146910		Axle arm le.w.bushings	1
24147010		Axle arm ri.w.bushings	1
24147501		Maestro Scraper, left w/ carbide	1
24147502		Maestro Scraper, right w/ carbide	1
24246430		Seed Tube w/ Senser 8v	1
60024724		Cam for depth adjustment 24112000	1
60026994		Sensor Seed Tube Brush 23249402	1
60163747		Bolt adjustment depth control 24019100	1
60163751		Pin, 12x85, with clip 24112900	1

Part No	Part	Description	Qty
M1A06060		Hex Bolt M6-1.0x60 DIN931	1
M1A08012		Hex Bolt M8-1.25x12 DIN933	5
M1A08080		Hex Bolt M8-1.25x80 DIN931	1
M1A12025		Hex Bolt M12-1.75x25, DIN933	2
M1A16075		Hex Bolt M16-2.0x75 Gr8.8	2
M1D12020		Socket Bolt, M12- 1.75x20 DIN912	2
M2B16045		Hex Bolt M16-1.5x45, LH, DIN961	1
M2Q16045		Hex Bolt M16-1.5x45, LH, DIN961	1

Part No	Part	Description	Qty
M3A12000		Hex Nut, M12-1.75, DIN934	2
M3C06000		Nut Nylock M6-1.0 DIN985	1
M3C08000		Nut Nylock M6-1.25 DIN985	1
M5A08000		Washer, flat M8, DIN125	5
M5A12000		Washer, flat M12, DIN125	2
M5F08000		Lock Washer, M8	5
M5F16000		Lock Washer, M16, DIN127	4

MAESTRO SW - TENSION SPRINGS DIAGRAM

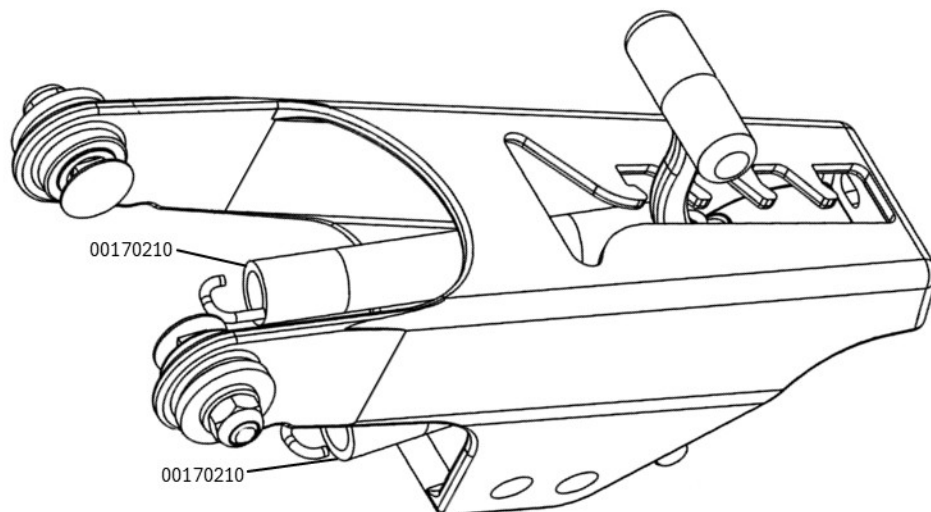

MAESTRO SW - ROW UNIT BODY ASSEMBLY DIAGRAM

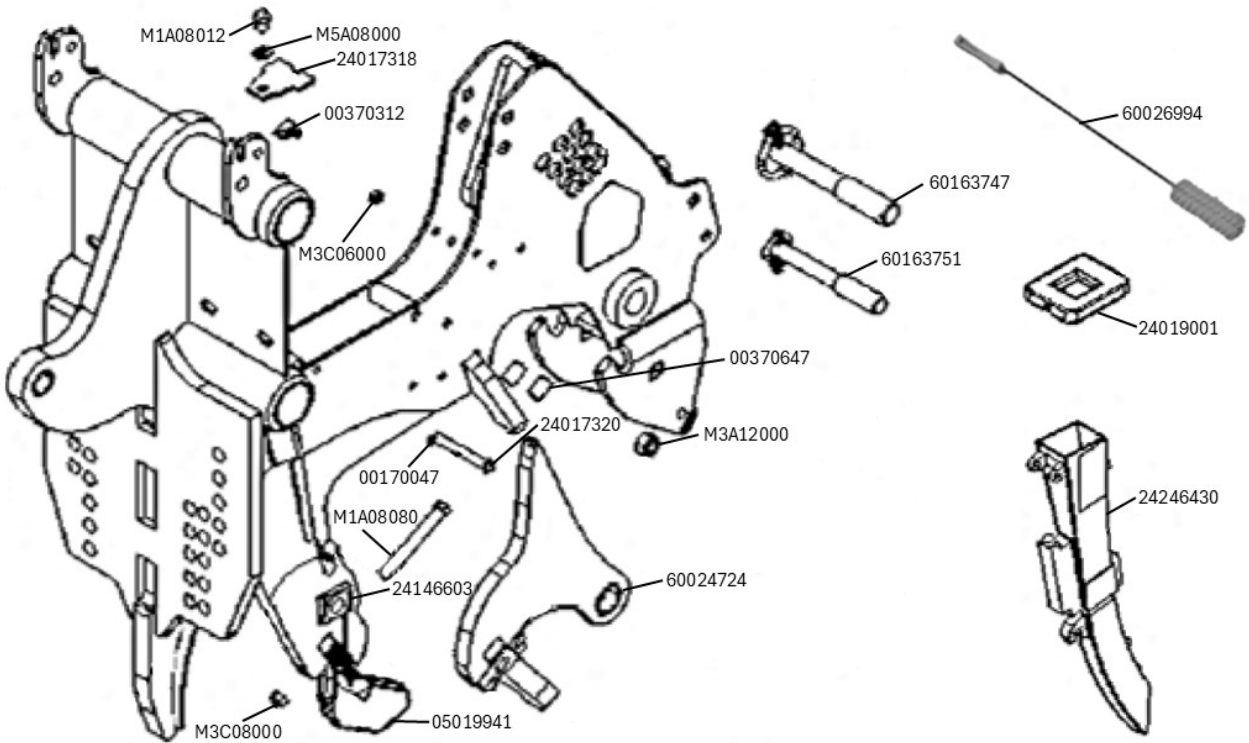

MAESTRO SW - ROW UNIT BODY ASSEMBLY DIAGRAM

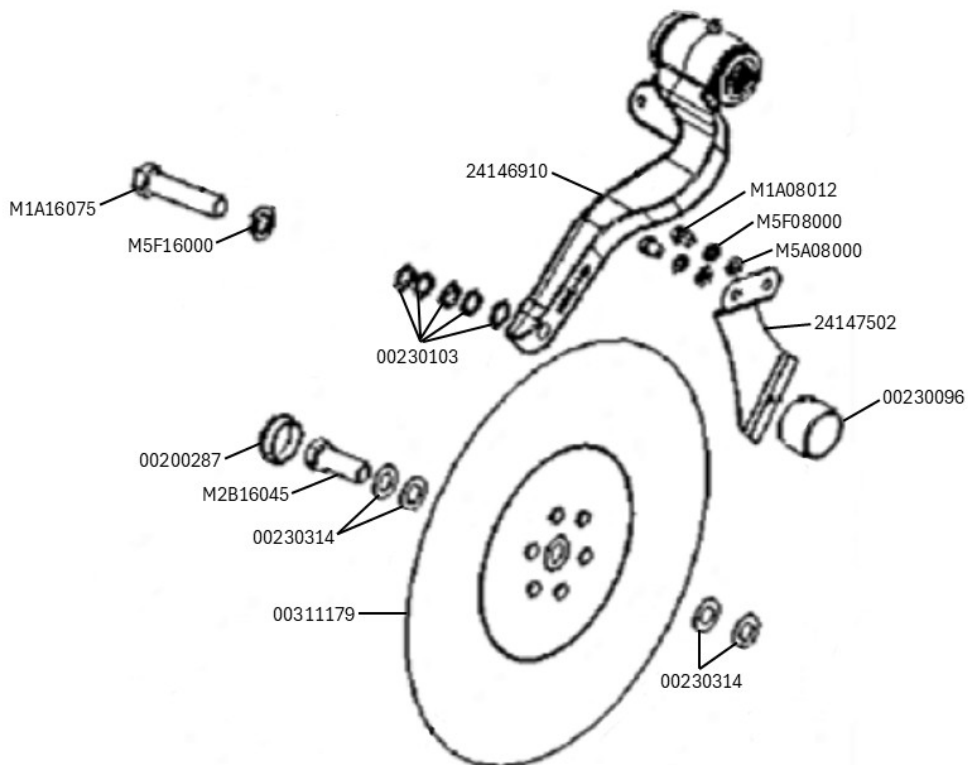

MAESTRO SW - ROW UNIT BODY ASSEMBLY DIAGRAM

